



# Motion C5 Mobile Clinical Assistant User Training Manual

## Learning objectives: At the end of this course, the learner will

1. Demonstrate understanding of the functionality of the Motion C5 Mobile Clinical Assistant
2. Demonstrate understanding of the cleaning, charging and storage of the Motion C5 Mobile Clinical Assistant.
3. Demonstrate the ability to use the Motion C5 Mobile Clinical Assistant in a full slate mode using the Motion pen for data entry
4. Demonstrate the ability to use the Motion C5 Mobile Clinical Assistant's barcode, camera, and RFID functionality if applicable

## Total course time:

2 hours for basic class

2.5 hours if adding barcode scanning **or** biometric enrollment

3 hours if adding barcode scanning **and** biometric enrollment

## Audience:

Clinicians who will be using Motion C5 Mobile Clinical Assistant for entering clinical documentation

## Preferred classroom setup:

- U-shaped setup preferred or classroom style with center and side aisles to allow for easy access to learners
- Room should have wireless access and Motion C5 Mobile Clinical Assistant should be configured to access facility clinical software either in training system or on training patients in live system to allow for real-live practice
- One Motion C5 Mobile Clinical Assistant configured to facility system hooked to projector for instructor to demo actions
- One Motion C5 Mobile Clinical Assistant with flex dock and keyboard (and mouse if keyboard does not have touchpad or pointer) per learner
- If available, one super-user should be available to serve as second trainer to help individuals

## Web Sites of Interest

- [Motion Computing Support Website](#)
- [Motion C5 User Guides](#) are found in electronic version on each C5 and are downloadable from our website
- [Motion Tips & Tricks](#)
- [Free online video training tutorial for using the barcode scanner](#)



Esis Pty Ltd www.esis.com.au

## Agenda

### Motion C5 Mobile Clinical Assistant Overview

- Motion Company Intro
- Course Introduction
- Motion C5 Mobile Clinical Assistant differences and similarities to a standard PC

### Motion C5 Mobile Clinical Assistant Fundamentals

- Hardware tour of chassis and docking station
- Logging on

### Customizing Your Motion C5 Mobile Clinical Assistant Environment

- Set handedness
- Calibrate pen to digitizer
- Hands on exercise

### Pen and Ink Introduction

- Digital pen basics
- Using the pen as a mouse
- Hands on exercise

### Using Handwriting Recognition to input text

- Accessing and using the Tablet Input Panel (TIP) to insert text
- Changing the pen tip
- Hands on exercise

### Power Management

- Checking your battery power level
- Charging the battery
- Changing the battery
- Hands on exercise

### Caring for Your Motion C5 Mobile Clinical Assistant

- User maintenance tips and tricks
- Replacing the pen tip

### Microsoft Journal Fundamentals

- Access and basic use (hands on exercise)
- Converting ink to text
- Organizing your Journal notes
- Hands on exercise

### Using Sticky Note

- How to use
- How to delete
- Hands on exercise

### How to Obtaining Additional Support

- Accessing the *on-board* tutorials and user guide
- Motion web site support resources

### Optional based on facility need:

- Configuring and using the Motion OmniPass fingerprint reader
- Using Voice Recognition

### Practice using facilities' software on Tablet

## Table of Contents

Benefits of the Motion C5.....	4
Getting Started with the Motion C5 .....	5
Hardware Fundamentals .....	5
Logging on to C5 .....	8
Holding the C5.....	9
Customizing Your Motion C5 Environment .....	10
Motion Dashboard .....	10
Pen and Ink Introduction .....	11
Accessing and using the Tablet Input Panel (TIP) to insert text.....	12
Using the Writing Pad .....	14
Using the Character Pad .....	15
Using the on-screen keyboard.....	16
Adding words to the TIP dictionary.....	17
To add a word to the handwriting dictionary .....	17
Additional Writing Tips.....	17
Power Management .....	18
Checking your battery power level .....	18
Charging the battery .....	18
Best Practices: Extending Battery Life .....	19
Using the Bar Code Reader.....	20
Holding the C5 for bar code scanning of medication.....	21
Holding the C5 for bar code scanning of patient wrist bands .....	21
Using the Camera .....	22
Using the RFID Reader.....	23
Caring for Your Motion C5 Mobile Clinical Assistant .....	24
Disinfecting Procedures .....	24
Pen tip .....	24
Additional Support.....	25
Optional Topics .....	25
Microsoft Journal .....	25
Microsoft Sticky Notes .....	26
Motion OmniPass fingerprint reader.....	26
Voice Recognition .....	26
Practice with facility's software .....	27
Competency Check-off Sheet .....	28
Motion C5 Mobile Clinical Assistant Competency Test.....	29

## Benefits of the Motion C5

The Motion C5 saves time, reduces errors and ensures that the most up-to-date information stays at your fingertips throughout all stages of the care delivery process. This can result in:

- Increased mobility and accessibility
- Automation of forms, processes and workflows
- Greater access to data at the point of care
- Elimination of duplicate efforts
- Facilitation of real-time communications
- Improvements in patient charge capture
- Increased patient safety

The Motion C5 has been designed with clinicians in mind. It's weight is a bit over 3 lbs with a 10.4" display screen. It was built to withstand the rigors of the healthcare environment with a magnesium-alloy internal frame, a disinfectant-resistant resin shell and a shock-mounted 1.8" hard drive with DataGuard Accelerometer which "parks" the hard drive if it senses a dropping motion.

It is highly sealed and easy to disinfect with a virtually "port-less" design, sealed display, sealed speaker and buttons, liquid-resistant coating over microphones, and a sealed fan assembly

# Getting Started with the Motion C5

## Hardware Fundamentals

These illustrations show the basic features of the C5 and docking station required by the clinician. For further information about the functionality, please see the C5 user's guide found in .pdf format on each C5 or on our website at <http://www.motioncomputing.com/support/>. Please note that the C5 product DOES NOT contain any latex products.

There are two types of displays; the standard acrylic display and the View Anywhere Display (VAD). The VAD screen is glass bonded to the standard acrylic digitizer display and is an optically enhanced display that reduces glare in bright light environments. This solution was designed for mobile users that use tablet PCs in bright light environments.

### Mobile Clinical Assistant (MCA) – Front View

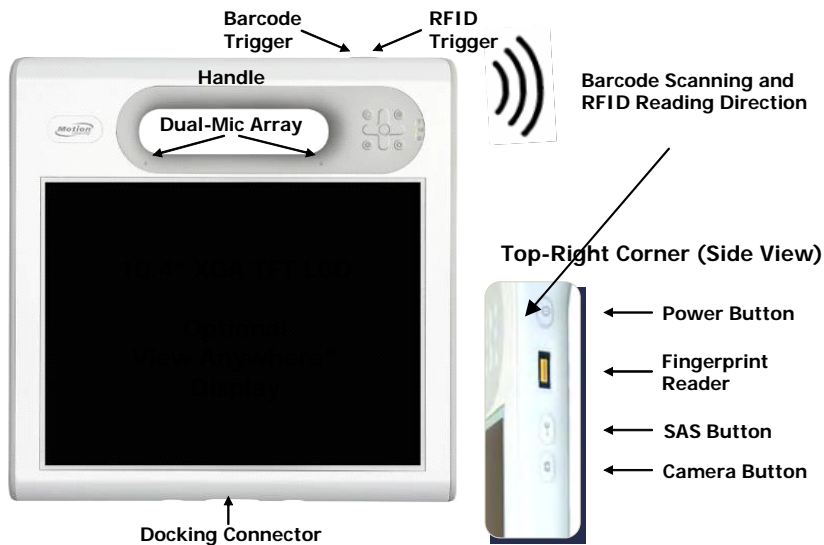

### Mobile Clinical Assistant (MCA) – Top Right Corner

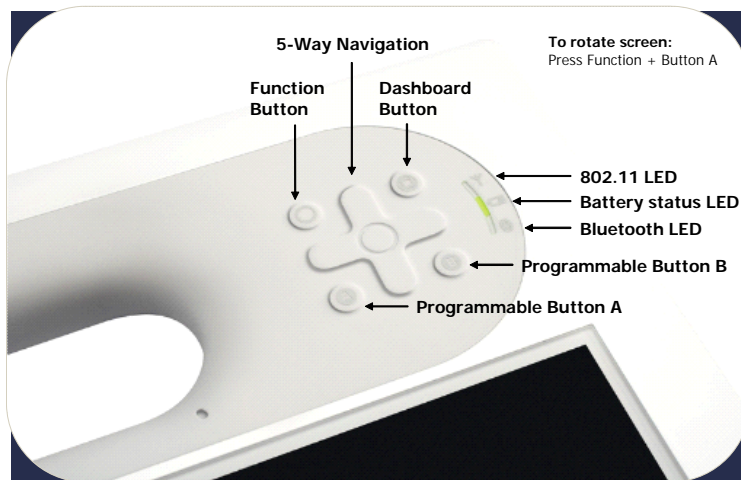

### Mobile Clinical Assistant (MCA) - Rear View

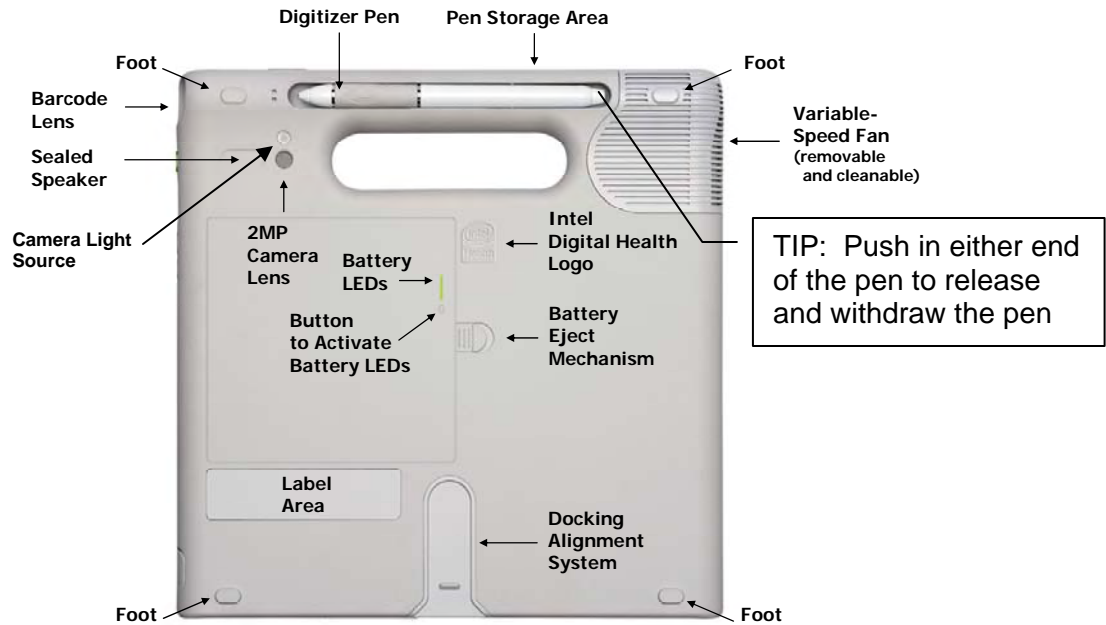

### MCA Dock - Front View / Left Side



### MCA Dock - Front View / Right Side

**Note: for more detailed information on using the C5 Docking Station, please see the Docking Station User's Guide found on the C5 or on our website**

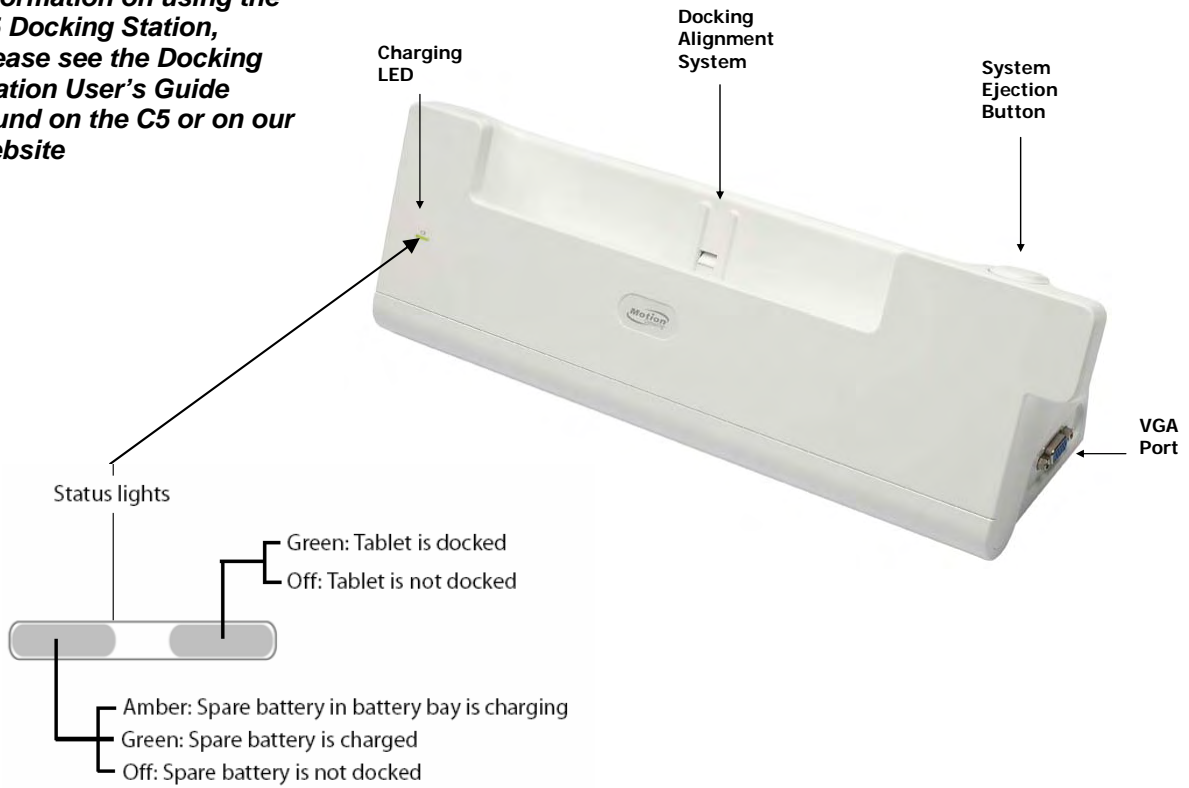

### MCA Dock - Rear View



## Logging on to C5

To power up the C5, use the following steps:

1. Press the Power Button for a second or two-note the green light that surrounds the button will come on
2. When the Windows login asks you to press "CNTL-ALT-DEL" keys, you will press the SAS button on the right side of the C5. This button has the picture of the key.
3. Use the pen and on-screen keyboard and enter your username
4. Either use the TAB button on the keyboard or use the pen and tap in the password field
5. Use the pen and on-screen keyboard and enter your password
6. Note: You may just have to enter your password as the username field is already populated

### Top-Right Corner (Side View)



← **Power Button**

← **Fingerprint Reader**

← **SAS Button**

← **Camera Button**

**Tip:** You can reposition by taping and dragging the Keyboard or enlarge the KB size by "pulling on the top and sides

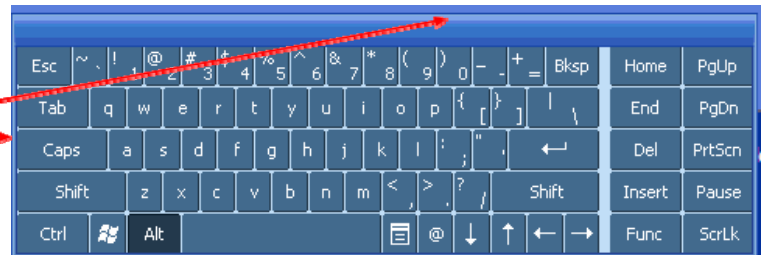

#### Helpful Hint

Depending on the complexity of your organization's logon, the easiest way to accomplish the logon process might be to place the C5 in a docking station and using the keyboard and mouse.

## Holding the C5

There are many ways to hold the C5 and you will need to find the ways that are most comfortable for you. A common way to hold the C5 when you are standing is in the crook of your arm as shown in the pictures below.



The screen can also be rotated to landscape mode and held as demonstrated in the picture on the left. Please remember that not all software applications are designed to be viewed in landscape mode and may not work properly.

- ◆ Rotate your screen for portrait mode viewing
  - Press the function button then the A button for screen rotation
  - Each press rotates the display 90°

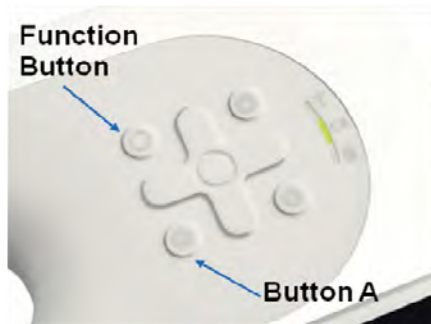

When you are sitting, hold the C5 comfortably similar to the way you would hold a clipboard.



## FAQ: My screen has gone black

Your C5 has either entered a power saving or standby mode.

1. Use your pen and tap the screen or....
2. Press a button

Is your display back?

1. Look at the power button light
2. Is it blinking or off?
  - Blinking = Standby mode (very quick restart)
  - Off = power off (either full reboot or resume from hibernate)
3. Press and release the power button to either reboot or bring the C5 out of standby mode

## Customizing Your Motion C5 Environment

### *Motion Dashboard*

The Motion Dashboard is a software application on the C5 tablet and is used to customize the computer environment in two ways that are important to clinicians:

1. Changing the screen brightness – Caveat: the brighter the screen the most battery power is used so it is recommended that the screen brightness be at the lowest brightness that is comfortable for the user
2. Calibrating the pen tip -

To open the Dashboard click on the top right button on the C5



To calibrate the pen tap on Pen & Tablet menu on left side of dialog box

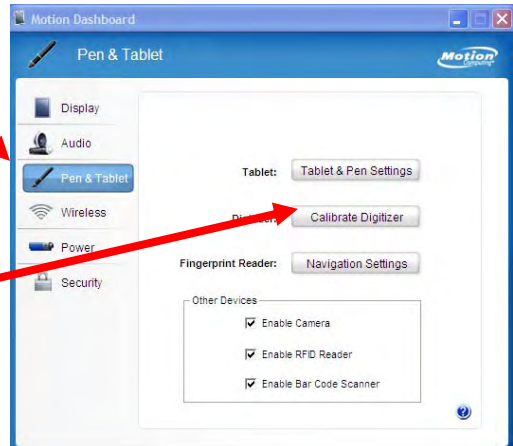

Then tap on Calibrate Digitizer button and follow directions on the screen

To change the brightness of the screen tap on Display menu on left side of dialog box

Use the slider bar to move between Dim and Bright as needed



#### Hands on exercise:

- Use the calibration feature
- Change the brightness of the screen manually

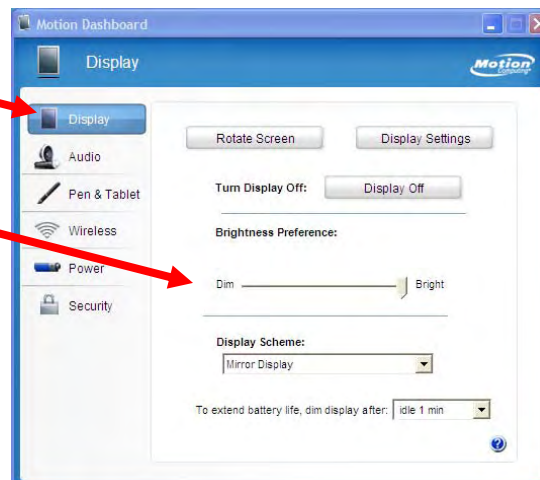

## Pen and Ink Introduction

### Digital pen basics

- When you write with the pen, you can rest your hand or arm anywhere without disturbing any open programs or damaging the display.
- Watch the cursor instead of the pen tip when you write. The cursor is a guide for your pen movements. If it does not align with the pen tip, you should recalibrate the pen – see instructions above.
- Practice writing and learn how firmly and where to tap on the Motion C5 Mobile Clinical Assistant screen.
- The pen can be held like any other writing tool. Learn how to hold it and when and how to press the pen function button, which activates right-click options (such as pop-up menus). You can also activate the right-click options by pressing and holding the pen tip on the surface of the display.

### Using the pen as a mouse

- Tap — Firmly tap the pen on the Motion C5 Mobile Clinical Assistant display, without pressing the function button on the pen; a tap equals a mouse left-click
- Double-tap — Tap the pen twice on the display, without pressing the function button on the pen
- Right-click — Press the function button on the pen and tap the pen on the display (equals a mouse right-click)
- Press and hold — Press and hold the tip of the pen to the display without pressing the pen function button (equals a mouse right-click)
- Select/Highlight — To select a letter, word, or line of text, drag the pen across the text to highlight it.



#### Hands on exercise:

Practice above skills. Use Microsoft Notepad, WordPad or Word if needed.

If it feels like the pen tip is scratching the display surface then the pen tip needs changed. The pen tips are softer than the display screen and will not scratch the screen however dirt/grit can become imbedded in the pen tip and that will scratch the screen. Pen tips have a life expectancy of 6 months to 1 year depending on use and environment.

To change the pen tips: Take the little silver metal C-shaped device that came with the pens and replacement tips. There is a notched area on one of the open end of the C. Use the C-shaped device like a pair of tweezers and grasp the end of the pen tip. Pull out the old pen tip and replace with a new one. NOTE: If your IT department did not provide you with replacement tips or the tip changing tool then contact your IT support group and request a new pen tip.

## Accessing and using the Tablet Input Panel (TIP) to insert text

The Motion C5 Mobile Clinical Assistant Input Panel (TIP) is the primary tool for entering text and provides several text correction and control options. The TIP also includes buttons for activating speech recognition and voice command capabilities. It is opened by tapping the TIP icon in the Windows task bar.

Tap the icon to open the Motion C5 Mobile Clinical Assistant Input panel (TIP). It is usually located at the bottom left of the screen next to the start menu



The Tablet Input Panel has three input modes: Writing Pad, Character Pad, and On-Screen Keyboard

Writing Pad: With some practice, you can use handwriting recognition 80-95% of the time

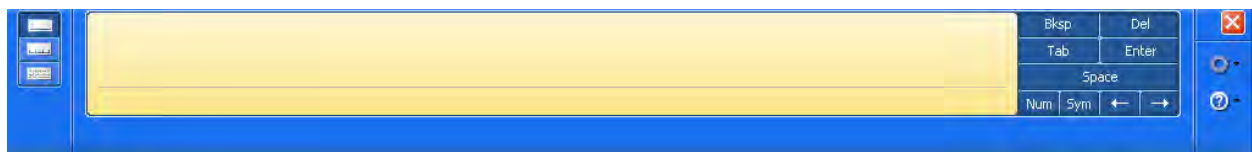

Character Pad: note the vertical lines that make a space for each character – this is good for writing complicated names or medications with letters and numbers such as D51/2NS

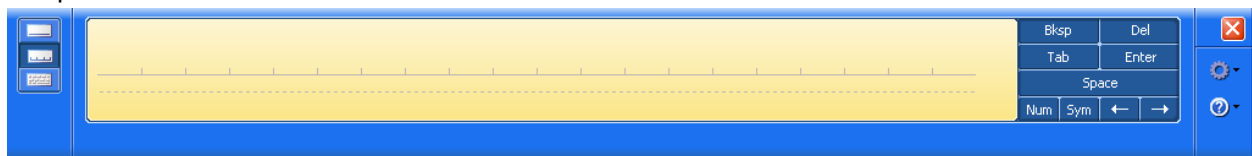

On-Screen Keyboard: best used for User Names and Passwords



Writing Pad  
Character Pad  
On-Screen  
Keyboard



You can change from the writing pad to a character pad or on-screen keyboard at any time by tapping the appropriate icon on the left side of the TIP panel.

On the right side of the TIP panel there are icons for *Tools and Options* and for *TIP Help*.

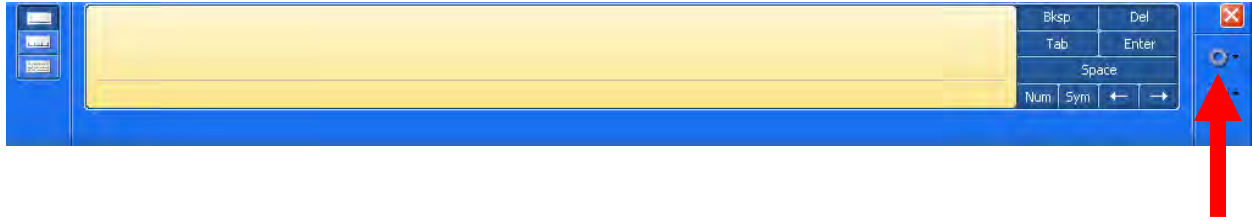

Click on the gray gear icon *Tools and Options*

This will bring up the menu that will allow you to put the TIP at the top of the screen or the bottom by clicking on the “*Dock at the Top of the Screen*” or “*Dock at the Bottom of the Screen*.”

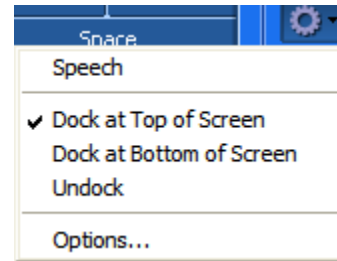

If you dock the TIP at the top of the screen the TIP will automatically expand as you had more lines. Below is an example of how the TIP will expand when docked at top of screen. However, if the TIP is docked at the bottom of the screen, it has no room to expand and you will need to tap on *Insert* at the end of each line.

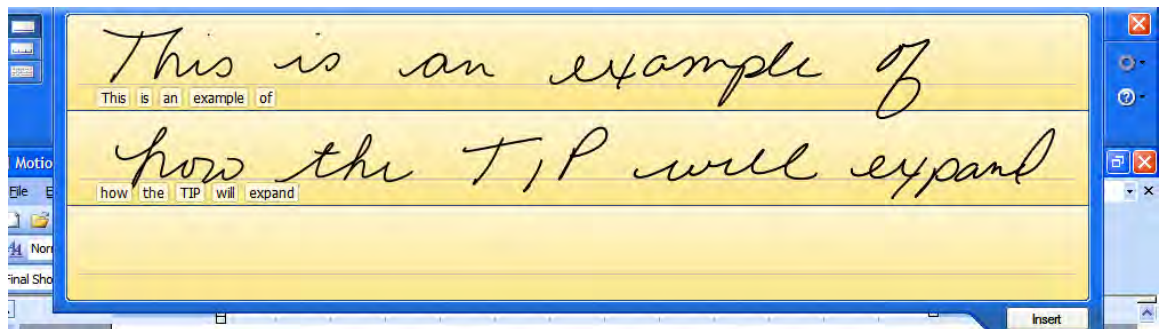

If you select “Undocked” the TIP tool will appear whenever you put the pen close to the screen and will disappear when you take the pen away. This is called the “floating TIP.” It is important to remember that this functionality may not work with certain applications or if you are using a Citrix environment. Your Help Desk or IT department will be able to tell you if you are using Citrix.

## Using the Writing Pad



### Helpful Hint

As you write, the software selects the best match for a word from its dictionary of words and displays it on-screen. Word recognition is based on shapes not actual words. You may write in block text or cursive script but avoid using all caps. The writing pad is the best mode for writing notes that are less than 2-3 sentences in length such as those you write during a shift assessment. If you are doing a full admission assessment, it may be easier to use a keyboard depending on the amount of free text entry required. Like any psychomotor skills, it will take some practice to learn to how the TIP recognizes your handwriting.

Handwriting recognition can not be “trained” to recognize your specific handwriting. It trains you to write more clearly 😊

### Correcting a Word in the Writing Pad

There are three ways to correct a word in the writing pad; correct by selection, correct by letter or erase the entire word and rewrite it.

If the word shown is not the correct word, tap on the word to select it. This will bring up the character pad and suggested words.

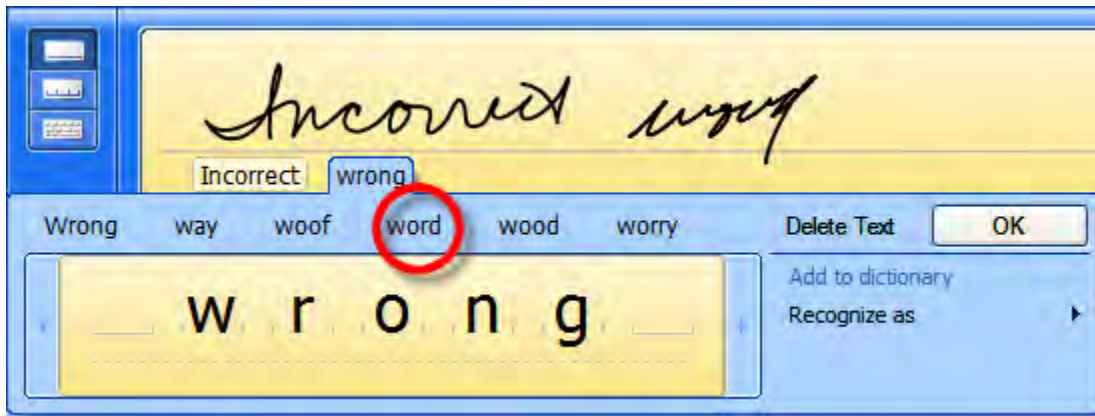

In the following example, either hand write directly over the incorrect character or tap the character to open a list of alternatives (as shown here: O, 0, a, 6). You can erase a word you have just written, by rapidly scratching back and forth over it. See instructions further on in this manual.

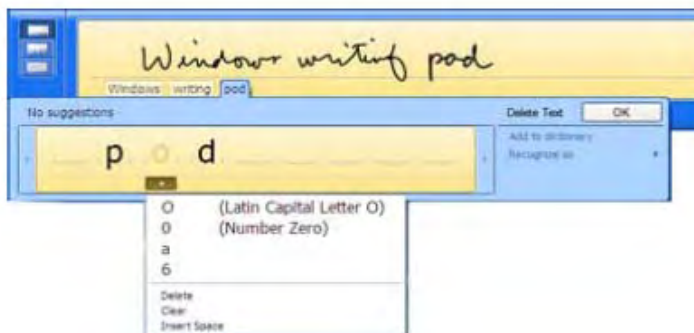

The writing and character pads expand to show Numbers (Num) or Symbols (Sym) toolbars, whose symbols are inserted immediately in the text entry area as you select them. Then, when you begin to hand write on the writing or character pad, the Num or Sym toolbar closes.

Number pad can be useful for entering vital signs and I&O



**Helpful Hint**

Erase by scratching through entire word: Must scratch back and forth in a straight line two or three times; not in circles. Start your line before the word and end the line after the word. You can also use a Z-shaped motion.

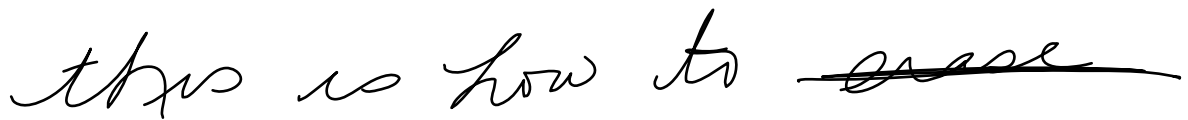

**Hands on exercise:**

Practice above skills. Use Microsoft Notepad, WordPad or Word if needed.

**Using the Character Pad**

Use the character pad for acronyms, equations, or other entries that require individual letters, numbers, or symbols that the writing pad may interpret incorrectly. Some examples include the following: ~ ! @ # \$ % ^ and\*( ) \_+ < >{ }[ ] \ / . Symbols/letters are displayed in a text equivalent that you can individually correct by:

- Handwriting over the text equivalent in each character space
- Clicking on the arrow under the letter and selecting an alternative from the drop-down menu

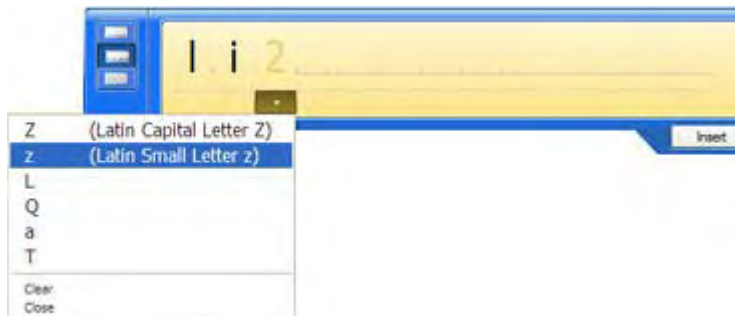

The character pad expands vertically when you get near the end of the panel if you are docked at the top of the screen.



**Using the on-screen keyboard.** You can use the on-screen keyboard to type words, letters, numbers, and characters from keyboard using your pen. For improved security and accuracy, you may want to enter passwords with the onscreen keyboard instead of handwritten text.

**NOTE:** When using the on-screen keyboard, be sure to place your cursor where you want to enter text in the text entry box before you begin. Whatever you tap will be immediately placed at the insertion point.



- Customizing — Select **Tools and Options** (the gear icon) then **Options...** from the TIP window to open the **Options** window at the **General** tab. You can customize many features in the TIP. Select one or more of the tabs and set the desired options.
- Refer to the Help and the Tutorials that are provided as part of the Windows Operating System. Or refer to the Help information that is provided in the **Options** window.



**Helpful Hint**

In some software applications you can insert handwriting by tapping in the field or next to the blinking cursor in lieu of tapping the insert button on the TIP



**Hands on exercise:**

Practice with all three modes to determine your personal preference. Open Microsoft Word Pad or Word and practice entering text using all three modes of the TIP.

Hello, my name is [insert your name]. I am using the handwriting recognition feature of this tablet computer. I have to remember to write like I am back in school and write my letters clearly.

## Adding words to the TIP dictionary

You can greatly improve handwriting recognition for words such as proper names, acronyms, technical terms, and abbreviations by adding them to the handwriting dictionary.

### To add a word to the handwriting dictionary

1. Open Tablet PC Input Panel.
2. To display the writing pad, tap the Writing Pad button.
3. In the writing area, write the word that you want to add to the handwriting dictionary.
4. If the word is not in the handwriting dictionary, it might be recognized incorrectly. Tap the recognized text.
5. In the correction area, revise the text so that the word that you want to add to the dictionary appears.
  - o Make sure that you spell the word correctly. If you add a misspelled word to the handwriting dictionary, it could degrade the quality of your handwriting recognition.
6. Select *Add to dictionary*.

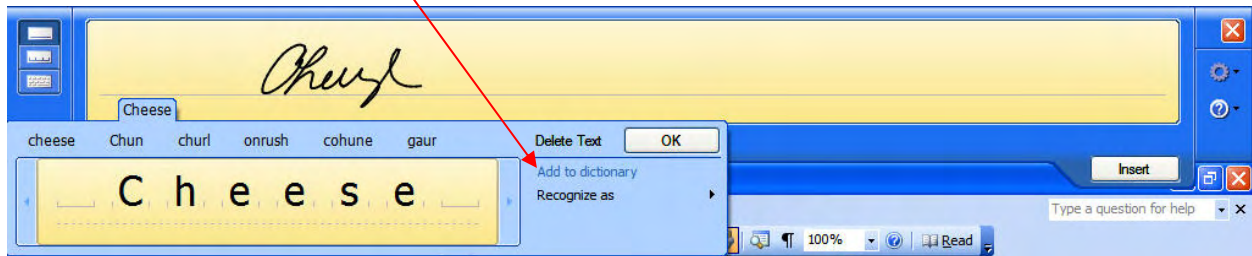

## Additional Writing Tips

Please note that the following tips work in a Windows environment however, they may or may not work in your clinical application.

If you want to select contiguous names or entries

- Tap/select the Shift Key
- Tap or select 1st entry to select
- Tap or select last entry to select
- Entries are now highlighted and ready to be copied via a drag and drop or right mouse button copy -> paste



Want to pick from a list of noncontiguous names or entries

- Tap Ctrl key then tap on each entry to be selected
- You can now drag drop or right click to get the menu and cut & paste

## Power Management

It is best to place your tablet in a powered docking station when not in use. This will help keep the battery at full power during your work so you may not need to change the battery during your shift. However, if your power gets to 15-20% you should either change the battery or charge it.

### Checking your battery power level

There are several ways to see how much battery power is left on your Motion C5 Mobile Clinical Assistant. You can determine the remaining battery power by doing any of the following:



- **Reading battery power from the Motion C5 Mobile Clinical Assistant display**

To check the power level while you are on battery power, move the pen over the Power Meter icon, shown here, in the system tray at the bottom-right corner of the Motion C5 Mobile Clinical Assistant display. Hovering over this icon shows the number of hours of battery power and the percentage of battery power remaining. (Also, the blue area on the battery icon, representing available power, changes to ½ blue and ½ silver then to almost all silver as the battery discharges.)



- **Reading battery power from the battery gauge (requires battery removal)**

Ensure that AC power is plugged into the Motion C5 Mobile Clinical Assistant, or that the Motion C5 Mobile Clinical Assistant is turned off. Turn the system over so that you are looking at the back and remove the battery from the top of the tablet. The gauge is mounted on the backside of the standard battery. If the light is not completely green, do not use this battery but place back in the charging area to continue charging.

### Charging the battery

When the Motion C5 Mobile Clinical Assistant (with a standard battery) is connected to AC power (plugged in), the battery automatically charges until it reaches full charge, even while the Motion C5 Mobile Clinical Assistant is being used. The Battery LED is the one in the middle with the picture of the battery to the right



**Battery LED Status:**

- Steady green 100% charged
- Amber charging
- Amber slow blink = 10% battery remaining
- Low power warning balloon displayed
- Amber fast blink = 3% battery remaining; goes to hibernate saves data

#### Important Points:

- Battery life is approximately 3 and 1/2 hours dependent on use
- Charge Time approximately 2 hours to fully recharge
- Can I Hot Swap Batteries (i.e. change battery without logging off and logging back on)? Yes, as long as power is being supplied to the tabled by either the docking station or with the power cord plugged directly into the C5

When the battery discharges to 10% a pop up balloon “low battery message” appears unless you are running in a Citrix environment. Ask your IT department if you are not sure if your organization uses Citrix. At 10% power, the battery LED slow blinks amber. If you ignore or do not see the warning, then when the Standard Battery reaches 3%, battery LED fast blinks amber and the system enters Hibernation mode

- When you try to reboot or power on the tablet the green power LED will flash momentarily but the C5 will not reboot.
- Attach the tablet to AC and power on
- Tablet resumes from hibernate mode
- A low power message may still be present
- Tap on the x to close it

### ***Best Practices: Extending Battery Life***

- Place your tablet in standby or hibernate mode when not using it during your work day
- Charge your tablet using AC power cord or docking station
- Fully charge your battery overnight
- Reboot at least once a week

### **Removing and replacing the battery**

Before you remove the battery, ensure that the C5 is plugged in, turned off, or in Hibernate or Standby mode.

#### **To remove the battery**

1. With the back of the unit facing you, slide and hold the battery latch.
2. Insert your finger under the finger grip and remove the battery from the battery compartment.

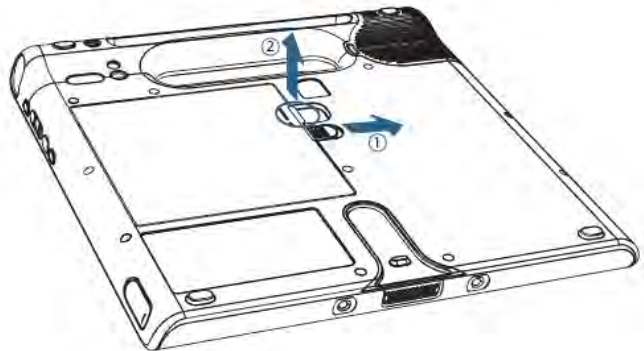

#### **Hands on exercise:**

Practice removing and inserting the battery

## Using the Bar Code Reader

There is a free online video training tutorial for using the barcode scanner found at:

[http://www.motioncomputing.com/products/training\\_C5\\_barcode.asp](http://www.motioncomputing.com/products/training_C5_barcode.asp)

Although the bar code reader emits a red light, it is not a laser but an imager that takes a picture of the bar code for the software to decode. Please note that the first time you use the bar code reader, it will take about 2-5 seconds for the software to open and then the bar code reader will activate.



Best Practice Recommendation: the bar code scanner default timing be increased to 30 seconds. This can be done by your IT department.

### To use the bar code reader

Medication Name	Amount	Route	Scan barcode into this field
Diazepam	10 mg	oral	<input type="text"/>

1. Open the application that you want to receive the bar code data and place the cursor in the appropriate field. If the cursor is not in the correct field then the information will not be scanned in the eMar even though you will get the "happy ta-ting" sound indicating a successful scan.
2. Aim the reader window at the bar code.
3. When ready to scan, firmly press and release the barcode trigger button in one quick motion.
4. You will then hear a "clunk" and a simultaneous flash of light. This means that the barcode reader has been initialized.
5. When the reader is ready to receive input you will hear a high-pitched "ta-da".
6. After the "ta-da" you will have ~10 seconds to perform a successful scan. If the scan is successful you will hear an even higher pitched "ta-ting" sound. If a scan is not successful (e.g. unable to read barcode within 10 seconds) you will hear a harsh failure sound (low tone "da-dong").
7. Hold the barcode 4-5" away from the reader to start. The longer the bar code the further away it needs to be so that the camera can see the entire bar code.
8. If you do not get a successful scan after a couple of seconds, slowly move the barcode left and right, then up and down, then back and possibly forward (SLOWLY). Do this one axis at a time (e.g. back/forth, up/down and then tilt).
9. Look for the darker red center bar and align the barcode with it until you get used to using the reader.

## ***Holding the C5 for bar code scanning of medication***



There are several ways to hold the C5 when using the bar code reader. You should experiment to determine the best way for you. You may use different holds depending on the task you are performing. The following pictures show various ways to hold the C5.



Rest C5 on counter and pass medication in front of bar code reader



Rest the C5 on your forearm and pass medication in front of bar code reader

## ***Holding the C5 for bar code scanning of patient wrist bands***



A recommended practice is to configure the "B" button on the front of the C5 to activate the bar code reader making it more flexible for individual user preferences. This can be done by your IT department.

When scanning the patient wrist band is best to hold the C5 by the side rather than the handle. You can hold in either your left or right hand.

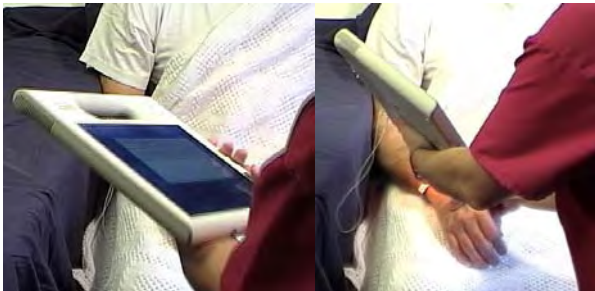

Using your left hand to scan patient wrist band



Using your right hand to scan patient wrist band

# Using the Camera

The camera lens light is on the back of the C5 and there is a light source just above it.



Please note that the first time you use the bar camera, it will take about 5-10 seconds for the software to open and then the camera will activate. You will see the following dialog box.

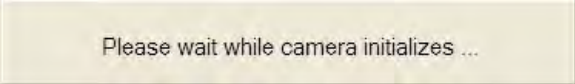

Subsequent scans will not have the delay for the software to open unless the computer is restarted.

1. Press the Camera button to activate the camera and open the viewfinder.



2. Press the Camera button again to take a picture.



3. In the Pictures dialog box, do one of the following:

- To save the picture, tap **Save**. In the Save As dialog box, specify a location in which to save the picture.
- To delete the picture, tap **Delete**. In the confirmation dialog box, tap **OK**.

## Tips

- If you are using a tethered pen make sure the tether is not in front of the lens
- Hold the camera steady and allow it to focus
- Make sure you have adequate lighting



# Caring for Your Motion C5 Mobile Clinical Assistant

## ***Disinfecting Procedures***

Disinfecting of the tablet is recommended periodically in accordance with the institutional policies of surface and device safety and cleanliness. Motion has tested a variety of antimicrobial solvents and information on specific products is available upon request.

Per the Center for Disease Control and Prevention, “items that do not ordinarily touch the patient or touch only intact skin are not involved in disease transmission, and generally do not necessitate disinfection between uses on different patients (CDC, 2002 para. 7).” Using an EPA-approved low-level disinfectant when general cleaning is required is recommended.

If the tablet becomes soiled with blood or other body fluids, a hospital-approved low-level disinfectant when used at recommended dilutions and contact times can be used to decontaminate spills of blood or other body fluids. Visibly soiled areas should first be cleaned and then disinfected, or a detergent disinfectant can be used. For disinfection, the pre-cleaned areas should be moistened with the appropriate disinfectant and allowed to air dry (CDC, 2000 para. 7 and 8).

If a tablet is used with patients who are infected or colonized with microorganisms judged by the infection prevention program to be of special or clinical or epidemiologic significance or with highly virulent microorganisms based on current state, regional, or national recommendations (such as Ebola or Lassa), then the tablet should be either dedicated to one patient or patient cohort or subjected to low-level cleaning between patient uses (CDC, 2002 para 8-10).



### **Tips**

- Clean the C5 with disinfecting cloths and wiping away any film they may leave – use a soft cleaning cloth not paper as paper contains wood pulp and may over time scratch the screen.
- Use only the Motion pen on the display. Do not write on the surface with an ink pen or pencil, or any pointed or other object that could damage the display surface.
- If you use alcohol prep pads or disinfecting products for cleaning the C5 surface and display screen a white haze residue will remain on the screen and it cannot be removed using paper based cloths. The blue Motion towel or any soft cloth will remove most of the residue. Your IT or support staff should be able provide these cloths.

### ***Pen tip***

- Always store pen in the pen holder when not in use.
- Do not store the pen vertically on the tip. Constant tip pressure can affect the pen-to-digitizer screen interaction.
- The pen contains sensitive electronics. Do not immerse it in liquids.

## Additional Support

- To access Motion C5 Users Guide and Quick Reference Guide go to  
Start -> All Programs -> Motion Resources
- To access the onboard tutorial for using a tablet PC go to  
Start -> All Programs -> Tablet PC -> Getting Going with Tablet PC

## Optional Topics

Based on user preference, Microsoft Journal or Sticky Notes could be used to jot notes to yourself during the workday. Illustrate the use of these two applications found under Start->AllPrograms -> Tablet PC Illustrate use and discuss ways to integrate into your workflow.

**IMPORTANT: Please be sure to follow your organization's HIPAA guidelines when taking notes or sending information.**

## Microsoft Journal

Journal is an "electronic notepad" that can replace a paper notepad. It can be used to:

- Draw or illustrate pictures
- Record your shift notes and to-do's

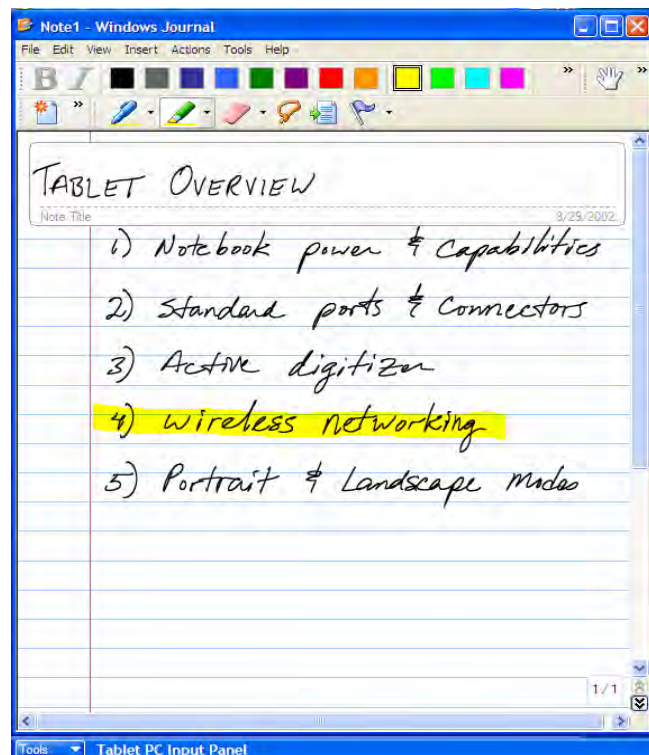

## Microsoft Sticky Notes

You can use Microsoft® Sticky Notes the same way that you use a paper sticky note—to retain names, phone numbers, simple maps with directions, and other information that you need to write quickly and keep easily available. You might want to use a separate one for each patient in your care.

For convenience and quick access, sticky notes are kept in a single stack that you can make "stick" to your desktop, are always visible and available. In addition, you can copy and paste sticky notes into other programs and import and export your stack of sticky notes.

Access via Start-> All Programs ->Tablet PC -> Sticky Notes

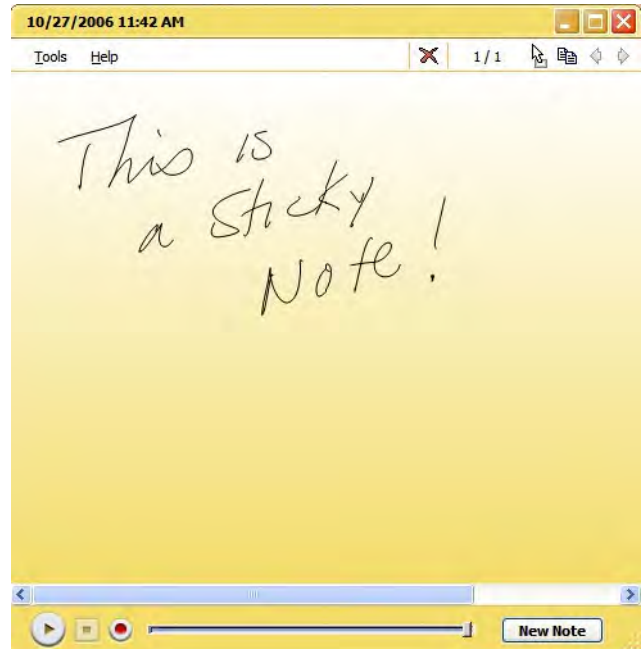

### Hands on exercise:

Practice with these two programs.

## ***Motion OmniPass fingerprint reader***

Consult the Motion C5 User's Guide for instructions on setting up and using the fingerprint reader. The Motion C5 User's Guide can be found at <http://www.motioncomputing.com/support/>

## ***Voice Recognition***

Consult the Motion C5 User's Guide for instructions on setting up and using the microphones and voice recognition. The Motion C5 User's Guide can be found at <http://www.motioncomputing.com/support/>

## ***Practice with facility's software***

Logging on to your facility test system or with practice patients, enter the following data using the pen as your input device:

Shift Assessment:

- Blood pressure (BP) 164/80
- Pulse 92
- Respiratory rate 24
- Temp 38.2 C / 100.8 F
- Pulse saturation 89%

Respiratory: Crackles in LLQ posterior, decreased breath sounds in all fields. No pain on inspiration. Dry cough. Uses incentive spirometer every hour to 900ml. You place the patient on Oxygen 2L via nasal cannula per order.

Cardiac: denies chest pain, normal sinus rhythm, radial pulses present and equal bilaterally

GI: Bowel sounds absent, states has not had a BM in 48 hrs, tender to palpation in LLQ

Skin: cool, dry, slightly pale, has a left flank incision with clean dry dressing in place, wound drain has scant amount of bloody drainage in it

IV: 20 gauge in his right forearm D5 ½ NS at 125cc/hour, site is slightly red, puffy, and tender to palpation. You remove IV and restart with 20 gauge in left forearm

Pain: rating pain at 7/10 – aching pain in left flank, increases with movement

Activity: up to bathroom without assistance. Walking slowly, stooped over and holding left flank

GU – 300 cc cloudy yellow urine in urinal, slightly foul odor – sample sent for UA per protocol

Teaching activity: signs and symptoms of potential urinary tract infection – demonstrated understand by repeating signs and symptoms and correctly identifying which are currently present

Psycho-social: Spouse and children at bedside, chaplain scheduled to visit today

## Competency Check-off Sheet

Learner: \_\_\_\_\_ Date: \_\_\_\_\_

The following skills will demonstrate the learner's basic competency using the Motion C5 Mobile Clinical Assistant. The leader should complete the self assessment and see the instructor for additional practice if unable to answer Yes. Select N/A if the skill was not covered in your training session.

Skill Validation:	Circle appropriate answer		
I am able to competent to perform the following skills on the tablet:			
Calibrate the Motion pen	Yes	No	N/A
Change the brightness of the screen	Yes	No	N/A
Use the Motion pen to navigate via point/click	Yes	No	N/A
Use the Motion pen to navigate via drop down menu	Yes	No	N/A
Use the Motion pen to navigate via radio buttons	Yes	No	N/A
Enter free text using handwriting recognition in the writing pad	Yes	No	N/A
Enter free text using handwriting recognition in the character pad	Yes	No	N/A
Enter free text using the onscreen keyboard	Yes	No	N/A
Check the battery power levels on the Motion C5	Yes	No	N/A
Change the battery in the Motion C5	Yes	No	N/A
Dock and undock the Motion C5	Yes	No	N/A
Use the bar code reader on the Motion C5	Yes	No	N/A
Use the RFID reader on the Motion C5	Yes	No	N/A
Use the camera on the Motion C5	Yes	No	N/A
Clean the Motion C5 in a clinical environment	Yes	No	N/A

My signature below indicates that I have practiced using the Motion C5 Mobile Clinical Assistant and am competent in the basic skills needed to use it in a clinical environment.

\_\_\_\_\_  
Learner's signature

# Motion C5 Mobile Clinical Assistant Competency Test

Learner: \_\_\_\_\_ Date: \_\_\_\_\_

- 1) The Motion C5 Mobile Clinical Assistant should be cleaned:
  - A) Using soap and water once every 8 hours
  - B) Using disinfectant per facility protocol and procedures
  - C) Clean with plain water when needed
  - D) Soak in disinfecting solution when needed
- 2) To use the handwriting features of the C5, I must write with block letters only
  - A) True
  - B) False

- 3) To determine the amount of battery charge remaining on the C5, I would:
  - A) move the pen over the Power Meter icon in the system tray
  - B) press the camera button
  - C) Press the button shown in Picture A



- 4) To engage the barcode reader -- to identify a patient, medication or employee, I would:
  - A) Aim the reader to the label, press the barcode indicator on the top of the C5
  - B) Aim the camera lens to the label, press the camera button
  - C) The C5 does not have the ability to scan barcode labels
- 5) The purpose of the dock station is: (select all that apply)
  - A) Charge the battery
  - B) Storage of the device
  - C) Connect a keyboard to the C5
  - D) Charge an extra battery
- 6) There are 3 methods to input data using the C5 without a keyboard: (select all that apply)
  - A) Writing pad
  - B) Character pad
  - C) Onscreen keyboard
  - D) Use regular pen on screen
- 7) The C5 is my personal device, it is ok for me to take it home or give to a patient family member
  - A) True
  - B) False, it is hospital property and should be secured to protect the asset

- 8) I must use the Motion Computing pen to use the TIP (Tablet Input Panel)
  - A) True
  - B) False



- 9) To change the brightness on the screen, I would
  - A) Press the button shown in Picture A
  - B) Open the Motion Dashboard to access the slider bar
  - C) Put my finger on the fingerprint reader and slide down

- 10) To change the orientation of the screen, I would
  - A) Use the Tablet Input Panel
  - B) Press the two buttons shown in Picture B
  - C) Press the button shown in Picture C

