



AC Current Transducer CT-453

1000A AC

GENERAL DESCRIPTION

The CT-453 probe is designed to easily measure current in industrial and power environments. The clamp on core design permits non-contact current measurements through magnetic field induction without requiring that the primary wire be taken offline and disconnected for CT installation. This allows for a safer and easier method of measuring current.

SPECIFICATIONS

Rated Input:	1.5 to 1000A AC @ 50/60Hz
Secondary Output:	5.0 VDC @ rated current Passive circuitry will be used for AC to DC conversion
Accuracy:	± 2.5% from 2% to 5% of rated current ± 1% from 5% to 100% of rated current
Response Time:	≤ 0.800 Seconds
Ripple:	≤ 1%
Burden Resistance:	≥ 100 kOhms
Operating Temperature:	-10° C to 60° C (14°F to 140°F)
Operating Voltage:	600V
Safety:	600V CAT III
Maximum Cable Diameter:	52mm (2.05 in.)
Dimensions:	108 x 216 x 45mm (4.25 in. x 8.50 in. x 1.77 in.)
Output Cable:	1.5m (60 in.) PVC insulated, reinforced coaxial cable



All measurements in millimeters

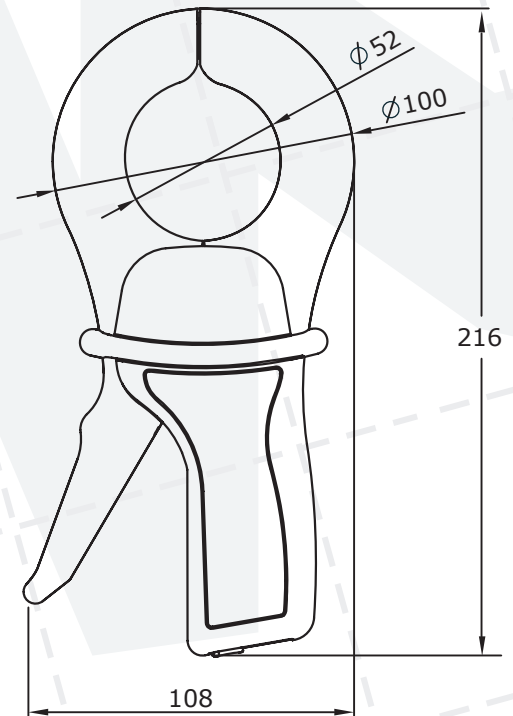

ORDERING INFORMATION

Item:
AC Current Transducer CT-453 (1000A)

Cat#:
35-0050